

包装规范

2. 高分子固态铝电解电容器

① 散装：标准品

分类	标准品			
尺寸	袋装数量	内箱	外箱	总重
ΦDxL(mm)	(pcs)	(pcs)	(pcs)	(kg)
5×7.5×9,6.3×5.4	2,000	16,000	32,000	11
5.5×9,6.3×6.6,6.3×8	1,000	12,000	24,000	10
6.3×10.5	1,000	10,000	20,000	14
8×8.8×9,8×11.5	500	7,500	15,000	17
10×12.5	200	4,000	8,000	15

② 散装：切脚&成形

分类	切脚&成形			
尺寸	袋装数量	内箱	外箱	总重
ΦDxL(mm)	(pcs)	(pcs)	(pcs)	(kg)
5×7.5×9,6.3×5.4	2,000	10,000	40,000	16
5.5×9,6.3×6.6,6.3×8	2,000	10,000	40,000	15
6.3×10.5	1,000	7,000	28,000	17
8×8.8×9	500	4,000	16,000	18
8×11.5	500	4,000	16,000	18
10×12.5	200	2,000	8,000	15

③ 折迭式编带(如图1)

分类	折迭编带品		
尺寸	数量	数量	总重
ΦDxL(mm)	(pcs)	(pcs)	(kg)
6.3Φ	2,000	10,000	8
8Φ×5-16L	1,000	5,000	7
10Φ×10~17L	600	3,000	7



图1

④ 圆盘式编带(如图2)

分类	圆盘编带品		
尺寸	内箱	外箱	总重
ΦDxL(mm)	(pcs)	(pcs)	(kg)
6.3Φ	2,000	10,000	6
8Φ×5-16L	1,600	8,000	12
10Φ×10~17L	1,000	5,000	14

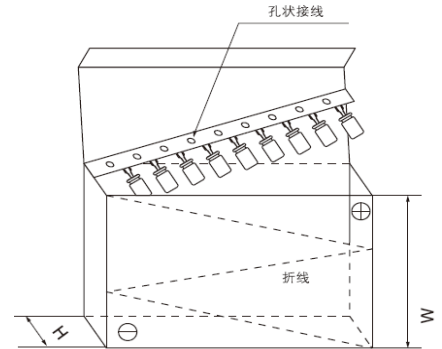

图2

3. 引线型铝电解电容器

① 散装：标准品

标准品					标准品				
分类	袋装数量	内箱数量	外箱数量	总重	分类	袋装数量	内箱数量	外箱数量	总重
尺寸	(pcs)	(pcs)	(pcs)	(kg)	尺寸	(pcs)	(pcs)	(pcs)	(kg)
DxL(mm)					DxL(mm)				
4×5	2,000	24,000	48,000	13	10×14~10×15	200	3,600	7,200	15
4×7	2,000	20,000	40,000	12	10×16~10×18	200	3,600	7,200	15
5×5	2,000	20,000	40,000	11	10×20~10×21	200	3,000	6,000	16
5×7	2,000	16,000	32,000	14	10×22~10×25	200	2,400	4,800	16
5×9~5×11	1,000	12,000	24,000	11	10×26	200	2,400	4,800	17
5×15	1,000	10,000	20,000	13	10×27~10×35	200	1,800	3,600	16
6.3×5	2,000	16,000	32,000	13	12.5×13~12.5×16	100	2,400	4,800	15
6.3×7	2,000	12,000	24,000	11	12.5×20~12.5×22	100	1,800	3,600	15
6.3×9~6.3×14	1,000	10,000	20,000	14	12.5×23~12.5×26	100	1,200	2,400	13
6.3×15~6.3×17	1,000	10,000	20,000	14	12.5×30	100	1,200	2,400	15
8×5~8×7	500	10,000	20,000	14	13×13~13×16	100	2,400	4,800	15
8×9~8×12	500	7,500	15,000	16	13×18~13×21	100	1,800	3,600	16
8×14~8×15	500	5,000	10,000	13	13×24~13×26	100	1,200	2,400	12
8×16	500	5,000	10,000	14	13×30	100	1,200	2,400	13
8×20~8×25	200	4,000	8,000	14	13×35~13×36	100	1,000	2,000	14
10×9~10×13	200	4,000	8,000	14	13×38~13×40	100	800	1,600	13

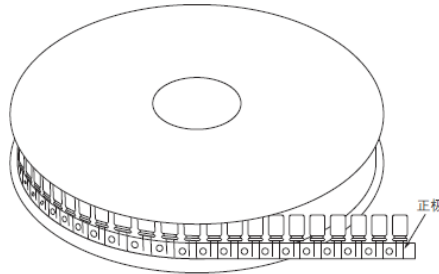
② 散装：切脚 & 成形

切脚&成形					切脚&成形				
分类	袋装数量	内箱数量	外箱数量	总重	分类	袋装数量	内箱数量	外箱数量	总重
尺寸	(pcs)	(pcs)	(pcs)	(kg)	尺寸	(pcs)	(pcs)	(pcs)	(kg)
ΦDxL(mm)					ΦDxL(mm)				
4×5	2,000	40,000	80,000	13	6.3×7	2,000	20,000	40,000	18
4×7	2,000	32,000	64,000	15	6.3×9~6.3×14	1,000	14,000	28,000	19
5×5	2,000	32,000	64,000	14	6.3×15~6.3×17	1,000	10,000	20,000	15
5×7	2,000	32,000	64,000	17	8×5~8×7	500	8,000	16,000	12
5×9~5×11	1,000	20,000	40,000	17	8×9~8×12	500	8,000	16,000	15
5×15	1,000	14,000	28,000	14	8×14~8×15	500	6,000	12,000	15
6.3×5	2,000	20,000	40,000	17	8×16	200	4,000	8,000	11

②散裝：切脚 &成形

切脚&成形					切脚&成形				
分类	袋装数量	内箱数量	外箱数量	总重	分类	袋装数量	内箱数量	外箱数量	总重
尺寸 ΦDxL(mm)	(pcs)	(pcs)	(pcs)	(kg)	尺寸 ΦDxL(mm)	(pcs)	(pcs)	(pcs)	(kg)
8x20~8x25	200	4,000	8,000	13	12.5x23~12.5x26	200	1,200	2,400	12
10x9~10x13	200	4,000	8,000	13	12.5x30	100	1,000	2,000	11
10x14~10x15	200	4,000	8,000	15	13x13~13x16	200	1,600	3,200	11
10x16~10x18	200	3,200	6,400	14	13x18~13x21	200	1,200	2,400	11
10x20~10x21	200	2,800	5,600	13	13x24~13x26	200	1,200	2,400	11
10x22~10x25	200	2,400	4,800	15	13x30	100	1,000	2,000	13
10x26	200	1,600	3,200	13	13x35~13x36	100	600	1,200	9
10x27~10x35	200	1,600	3,200	14	13x38~13x40	100	600	1,200	12
12.5x13~12.5x16	200	1,600	3,200	11	16x15~16x20	200	1,000	2,000	14
12.5x20~12.5x22	200	1,200	2,400	10	18x15~18x20	200	1,000	2,000	17

③格条式包装：标准品&切脚&成形(如图3)

标准品				切脚&成形			
分类	内箱数量	外箱数量	总重	分类	内箱数量	外箱数量	总重
尺寸 ΦDxL(mm)	(pcs)	(pcs)	(kg)	尺寸 ΦDxL(mm)	(pcs)	(pcs)	(kg)
8φ×50~60L	1000	2000	10	8φ×30~45L	1000	4000	13
10φ×30~45L	700	2100	16	8φ×46~50L	1000	3000	14
10φ×46~60L	700	1400	13	10φ×30~45L	700	2800	15
12.5φ×35~45L	460	1380	12	10φ×46~60L	700	2100	16
12.5φ×50~60L	460	920	13	12.5φ×40~45L	460	1840	13
16φ×15~20L	300	1200	9	12.5φ×46~55L	460	1380	12
16φ×21~26L	300	900	8	16φ×21~30L	300	1200	13
16φ×27~32L	300	900	9	16φ×31~45L	300	1200	16
16φ×33~40L	300	900	14	18φ×21~30L	250	1000	13
16φ×45L	300	600	12	18φ×31~45L	250	1000	19
18φ×15~20L	250	1000	9	18φ×50L	250	750	16
18φ×21~45L	250	750	14	22φ×25~30L	160	640	11
18φ×50L	250	500	11	22φ×31~45L	160	640	16
22φ×25~45L	160	480	13	22φ×50L	160	480	13
22φ×50L	160	320	11				

图3



图4



④折迭式编带(如图4)

折迭编带品				折迭编带品			
分类	数量	外箱数量	总重	分类	数量	外箱数量	总重
尺寸 ΦDxL(mm)	(pcs/箱)	(pcs)	(kg/箱)	尺寸 ΦDxL(mm)	(pcs/箱)	(pcs)	(kg/箱)
4φ×5~7L	3000	15000	5	12.5φ×12.5~31L	500	2000	14
5φ×5~15L	2600	13000	8	13φ×13~31L	500	2000	14
6.3φ×5~17	2000	10000	8	12.5φ×35~41L	500	1500	12
8φ×5~17L	1200	6000	10	13φ×35~41L	500	1500	12
8φ×18~30L	1200	4800	13	16φ×15~32L	300	1200	14
10φ×9~17L	800	4000	10	16φ×35~40L	300	900	13
10φ×18~32L	800	3200	11	18φ×16~32L	250	1000	16
10φ×35L	800	2400	14	18φ×35~35.5L	250	750	14

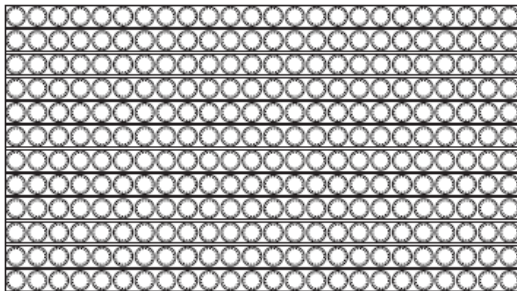
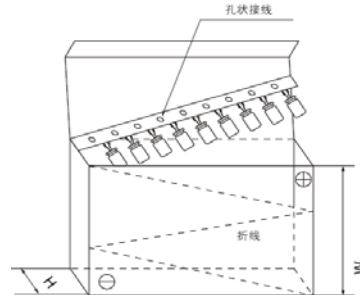
⑤圆盘式编带(如图5)

圆盘编带品			
分类	数量	数量	总重
尺寸 ΦDxL(mm)	(pcs/箱)	(pcs/箱)	(kg/箱)
4x5~7L	3,000	15,000	6
5x5~11L	2,400	12,000	8
6.3x5~11L	2,000	10,000	9
8x5~16L	1,600	8,000	12
8x20L	1,000	5,000	12
10x10~16L	1,200	6,000	13
10x17~20L	1,000	5,000	12

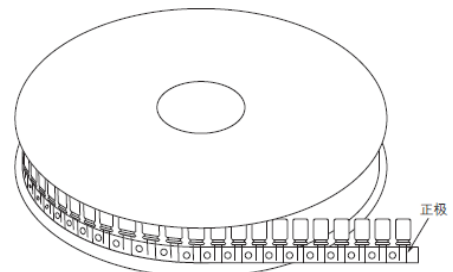

图

4. 焊针型铝电解电容器包装(如图6)

尺寸	单重	内箱	外箱
$\Phi D \times L$ (mm)	(g/pcs)	(pcs)	(pcs)
22x25 ~ 30	20 ~ 25	100	800
22x35 ~ 50	25 ~ 30	100	600
25x25 ~ 30	25 ~ 30	100	800
25x35 ~ 50	30 ~ 35	100	600
25x55~ 70	38.5~62	100	400
30x20 ~ 30	30 ~ 35	50	400
30x35 ~ 50	35 ~ 40	50	300
30 x 55~70	45~50	50	200
35x25 ~ 30	40 ~ 45	40	320
35x35 ~ 50	45 ~ 50	40	240
35x55 ~ 70	55~70	40	160



图6

5. 螺栓型铝电解电容器包装(如图7)

尺寸	内箱
$\Phi D \times L$ (mm)	(pcs)
35x50~100	42
51x70~115	40
64x96~115	15
77x100~236	15
90*105~236	12

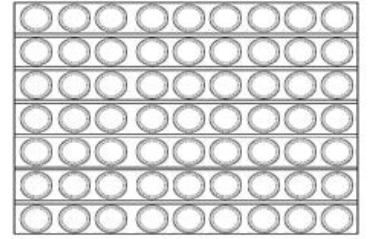
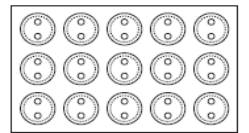
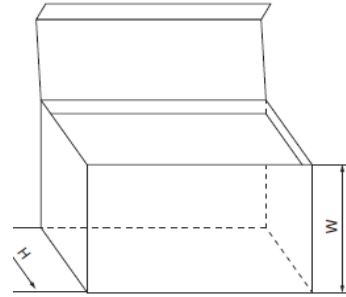

图7